

Data Sheet

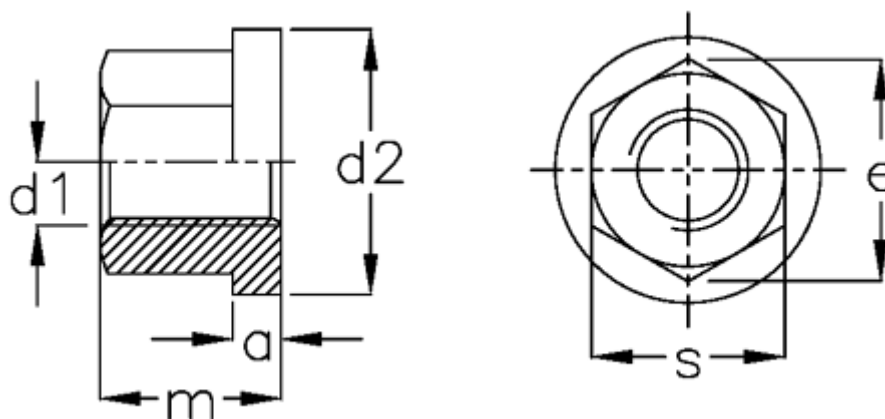

Article number: 20818517
Description: E+G Collar nut
DIN 6331-M30

Measures



$a = 8.0$
 $d1 = M30$
 $d2 = 58$
 $e = 53.1$
 $m = 45$
 $s = 46$